

02-139088, DGMPC-3-ABM-41

**DGMPC-3-41**

**General Description**

These valves provide pilot operated check functions in one or both service lines (A or B), the operating pilot supply coming from the opposite service line. Thus with pressure in one service line the check valve in the other service line will be open (subject to system/actuator pressures being correct for the valve area ratios).

A 3:1 area ratio of pilot piston to check valve seat is supplemented by an optional 10:1 decompression feature.

**Typical Section**

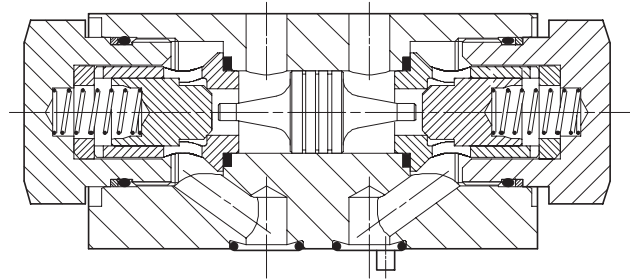

**Model Code**

**DGMPC -3- (D)\*\* \* [-(D)\*\* \*] - 41**

1
2
3
4
5
6
7

**1 Decompression feature**

**D** – 10:1 decompression ratio  
Omit if not required

**2 Function**

**AB** – Check in line A, pilot operated from line B  
**D** – Check in line B, pilot operated from line A (single check model only)

**3 Check valve opening/cracking pressure**

**K** – 1 bar (14.5 psi)  
**M** – 2,5 bar (36 psi)  
**N** – 5 bar (72 psi)

**4 Decompression feature (second function of dual models)**

As in **1**  
Omit for single line models, and if not required for dual models

**Note:** “D” must be specified here, for dual models, if called for **in**

**5 Second function of dual models**

**BA** – Check in line B, pilot operated from line A  
Omit for single line models

**6 Check valve opening/cracking pressure (second function of dual models)**

Options as in **3**  
Omit for single line models

**7 Design number, 41 series**

Subject to change. Installation dimensions unchanged for design numbers 40 to 49 inclusive.

**Functional Symbols**

DGMPC-3-(D)AB\*-(D)BA\*

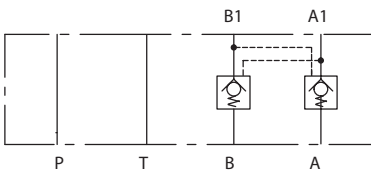

DGMPC-3-(D)AB\*

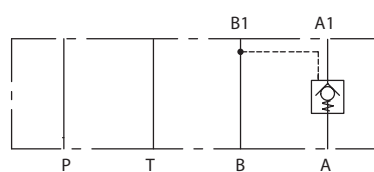

DGMPC-3-(D)BA\*

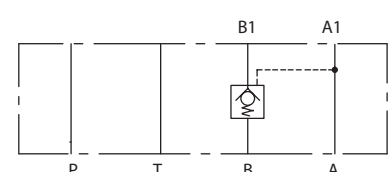

Maximum flow rate	60 L/min (16 USgpm)
Maximum operating pressure	315 bar (4500 psi)
Pressure drops	See graphs
Mounting position	Optional
Mass approximate	0.8 kg (1.81 lb)

## Performance Data

### Pressure Drop Data

Typical performance with mineral oil at 21 cSt (102 SUS) and at 50°C(122°F)

Pressure drop: flow path A1 to A or B1 to B (no pilot-pressure operation)

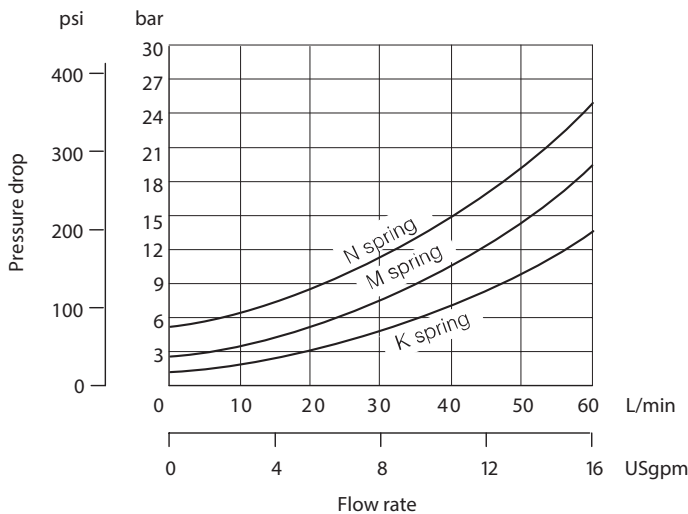

Pressure drop: flow path A to A1, or B to B1 with check valve pilot-operated fully open

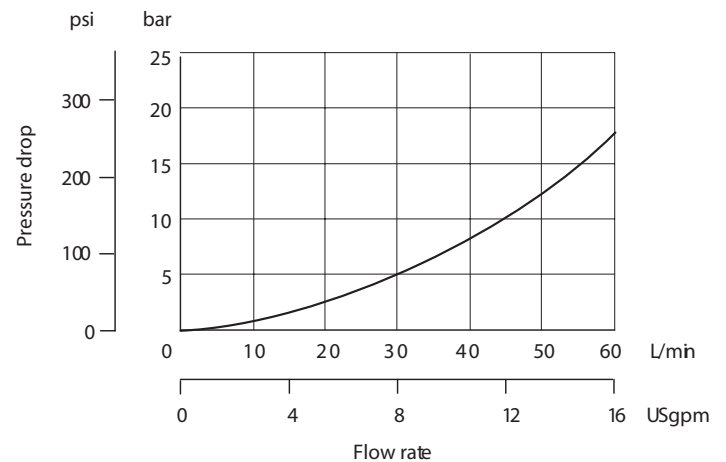

u For other viscosities, see "Further Information".

### Pilot Pressures

Pilot area ratios:

Main check valve ..... 3:1

Decompression poppet ..... 10:1

Use applicable ratio and opening/cracking pressure to calculate pilot pressure to open valve element, applied to the following formulae:

To open valve or decompression poppet in line A:

$$\text{Pressure at B1} = \frac{p_A + p_C - p_{A1}}{\text{Area ratio factor}} + p_{A1}$$

To open valve or decompression poppet in line B:

$$\text{Pressure at A1} = \frac{p_B + p_C - p_{B1}}{\text{Area ratio factor}} + p_{B1}$$

Where:

$p_A$  = Pressure at A

$p_C$  = Cracking/opening pressure

$p_{A1}$  = Pressure at A1

$p_B$  = Pressure at B

$p_{B1}$  = Pressure at B1

A = }  
 B = } Service line location;  
 A1 = } see functional symbols  
 B1 = }

### Leakage

Less than 0,25 ml/min (0.015 in<sup>3</sup>/min) at 250 bar (3625 psi).

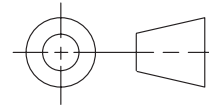

**DGMPC-3-(D)AB\*-(D)BA\*-41**

**DGMPC-3-(D)AB\*-41**

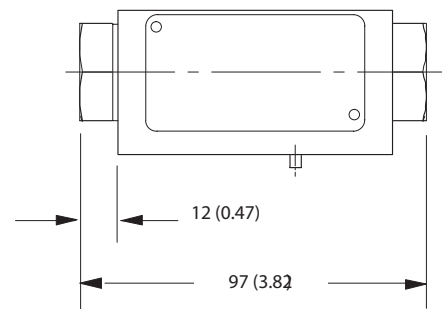
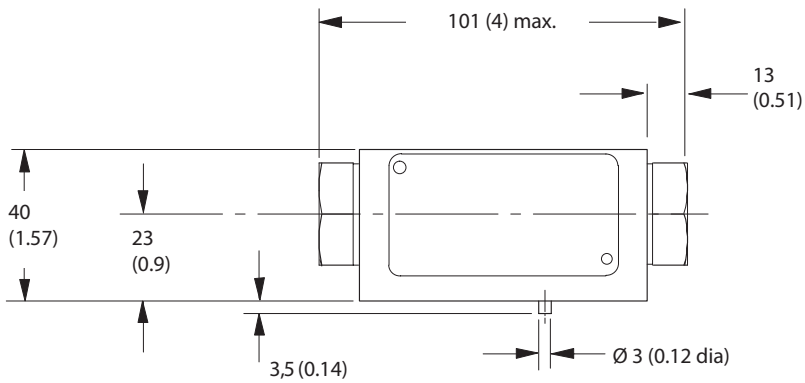
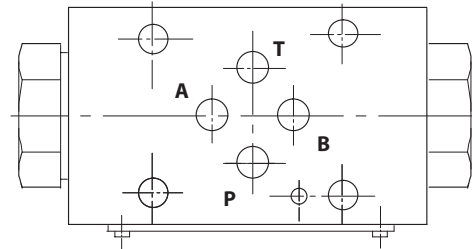
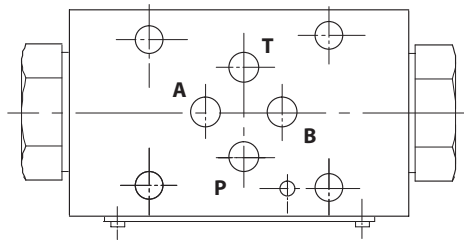

4 holes through: Ø 5,3 (0.21 dia)

4 off "O" seals supplied for this mounting face

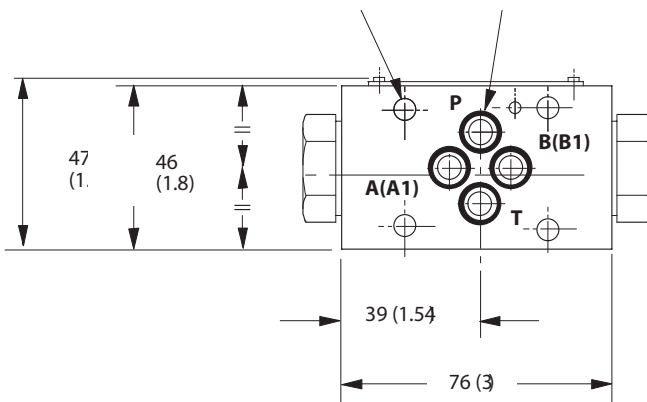

**DGMPC-3-(D)BA\*-41**

