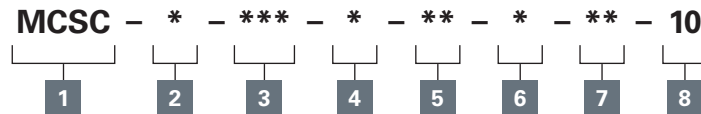

## Model code

**1 Function**

MCSC - Solenoid coil

**2 Series**

S - Size 8 (210 Bar)  
 P - Size 8 (350 Bar)  
 J - Size 10, 12, 16, 20 (210 Bar)  
 H - Size 10, 12, 16, 20 (350 Bar)

**3 Voltage rating**

012 - 12 volt  
 024 - 24 volt  
 115 - 115 volt  
 230 - 230 volt

**4 Voltage type**

D - DC  
 B - DC/with flyback diode  
 A - AC/with full bridge rectifier

**5 Connector**

GO - ISO 4400 DIN 43650  
 WO - Flying lead  
 NO - Deutsch Male, DT04-2P, Integrated (DC Only)  
 Mating Connector: Deutsch DT06-2S  
 YO - Integrated (DC Only)  
 Mating Connector: AMP 963040-3 or equivalent  
 DO - MetriPack® 150 Male, Integrated (DC Only)  
 Mating Connector: Delphi 12052641

JO - MetriPack® 280 Male, Integrated (DC Only)  
 Mating Connector: Delphi 15300027

EO - Weather-Pack (Packard) female on wire leads  
 Mating Connector: Delphi 12010973

FO - Weather-Pack (Packard) male on wire leads  
 Mating Connector: Delphi 12015792

**Note:** Auxillary parts forming connectors may be required.

**6 Lead length**

0 - None  
 A - 152mm [6.0 in] (Standard length with connector)  
 B - 610mm [24.0 in] (Standard length without connector)

**7 Special features**

00 - None  
 (Only required if valve has special features, omitted if "00.")

**8 Design code**

10 - Design code

## Specifications

## Ratings and specifications

Duty Rating	Continuous from 85% to 110% of nominal voltage
Operating temperature	100°C (212°F) continuous @ nominal voltage
Lead Wires	18 gauge, standard 610 mm (24") long, UL style 3173 CSA CL 1251 (meets SAE J1128 XLPE style SXL) S Series: 20W P Series: 23W J Series: 23W H Series: 29W
Power Rating	
Encapsulant	Glass filled nylon
Magnet Wire	U.L. class N, 200°C (392°F) NEMA pub. No. MW 1000, section MW 35 – C (single)
Flyback diode (arc suppressor)	Maximum recurrent peak reverse voltage – 800 V (optional)

## Environmental protection

Connector	Ip65	Ip67	Ip69k	Thermal shock dunk
GO: DIN 43650	X*			
YO: Amp Jr.	X	X*		
WO: Wire Leads	X	X		X <sup>1</sup>
NO: Deutsch	X	X	X	X
DO: Metri-Pack 150	X	X	X	X
JO: Metri-Pack 280	X	X	X	X

\*Rating dependent on mating connector

**⚠ Caution**

Coils may be hot to touch if used in continuous duty applications.

\*\*Additional coil information upon request

Where measurements are critical request certified drawings. We reserve the right to change specifications without notice.

# Toughcoils

For 8 size solenoid valves  
S & P series coils

## S Series Toughcoils part numbers - 300AA00\_\_\_\_\_ (Complete part number is 11 Digits)

Voltage	G0**	W0	N0	Y0	D0	J0	E0	F0
12VDC	001A	015A	021A	026A	031A	036A	182A	161A
24VDC	002A	016A	022A	027A	032A	037A	270A	250A
115VAC	005A	-	-	-	-	-	-	-
230VAC	006A	-	-	-	-	-	-	-
12VDC***	007A	019A	024A	029A	034A	039A	266A	177A
24VDC***	008A	020A	025A	030A	035A	040A	176A	379A

## P Series Toughcoils part numbers - 300AA00\_\_\_\_\_ (Complete part number is 11 Digits)

Voltage	G0**	W0	N0	Y0	D0	J0	E0	F0
12VDC	041A	055A	061A	066A	071A	076A	-	175A
24VDC	042A	056A	062A	067A	072A	077A	-	372A
115VAC	045A	-	-	-	-	-	-	-
230VAC	046A	-	-	-	-	-	-	-
12VDC***	047A	059A	064A	069A	074A	079A	-	178A
24VDC***	048A	060A	065A	070A	075A	080A	-	-

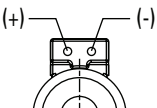
Std. voltages	S series Amperes*	P series Amperes*	Voltage Type B
12 DC	1.92	1.67	
24 DC	0.96	0.83	
115 AC	0.22	0.19	
230 AC	0.11	0.10	

\*Nominal voltage 25°C (77°F).

\*\*DIN 43560 mating connector for "G0" style coil – 02-166796.

\*\*\*With flyback diode. (Voltage Type B)

For other voltages and connectors contact your Eaton representative.

## J Series Toughcoils part numbers - 300AA00\_\_\_\_\_ (Complete part number is 11 Digits)

Voltage	G0**	W0	N0	Y0	D0	J0	E0	F0
12VDC	081A	095A	101A	106A	111A	116A	185A	172A
24VDC	082A	096A	102A	107A	112A	117A	201A	255A
115VAC	085A	–	–	–	–	–	–	–
230VAC	086A	–	–	–	–	–	–	–
12VDC***	087A	099A	104A	109A	114A	119A	251A	179A
24VDC***	088A	100A	105A	110A	115A	120A	–	265A

## H Series Toughcoils part numbers - 300AA00\_\_\_\_\_ (Complete part number is 11 Digits)

Voltage	G0**	W0	N0	Y0	D0	J0	E0	F0
12VDC	121A	135A	141A	146A	151A	156A	189A	163A
24VDC	122A	136A	142A	147A	152A	157A	162A	–
115VAC	125A	–	–	–	–	–	–	–
230VAC	126A	–	–	–	–	–	–	–
12VDC***	127A	139A	144A	149A	154A	159A	272A	180A
24VDC***	128A	140A	145A	150A	155A	160A	–	–

Std. voltages	J series Amperes*	H series Amperes*
12 DC	1.92	2.42
24 DC	0.96	1.21
115 AC	0.22	0.28
230 AC	0.11	0.14

### Voltage type B

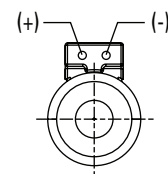

\*Nominal voltage 25°C (77°F).

\*\*DIN 43560 mating connector for “G0” style coil – 02-166796.

\*\*\*With flyback diode. (Voltage Type B)

For other voltages and connectors contact your Eaton representative.

# S and P Series coils

## Dimensions

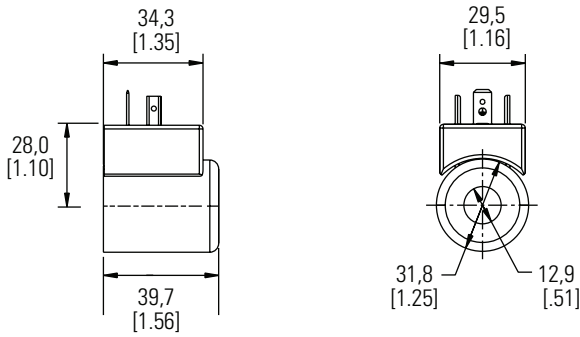

**G0**  
**DIN 43650-A Connector**

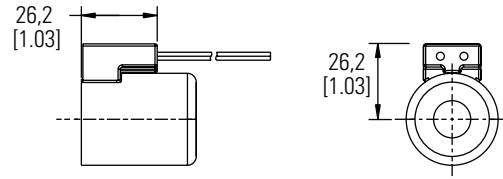

**W0**  
**Leadwire**

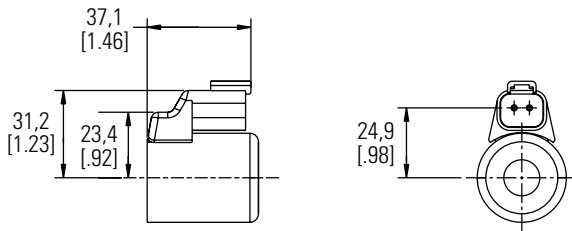

**N0**  
**Deutsch Male DTO4-2P integrated connector**

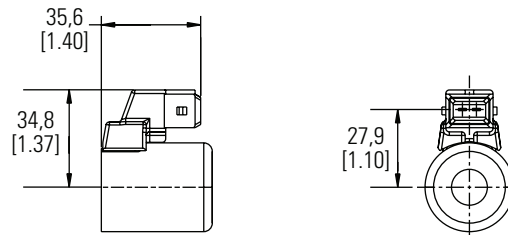

**Y0**  
**AMP Junior timer integrated connector**

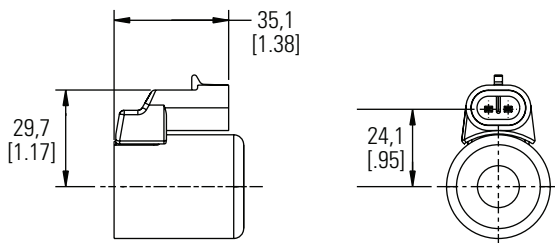

**D0**  
**Metri-Pack 150 Male, integrated connector**

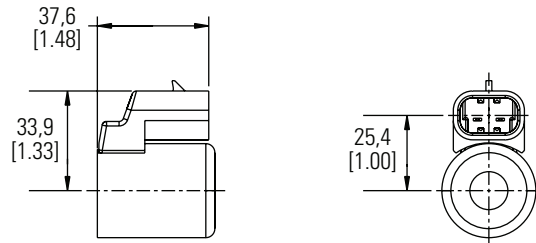

**J0**  
**Metri-Pack 280 Male, integrated connector**

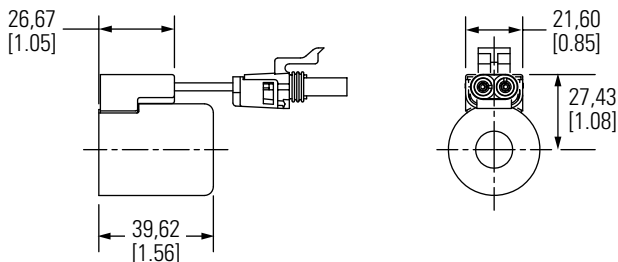

**E0**  
**Weather-Pack, Female**

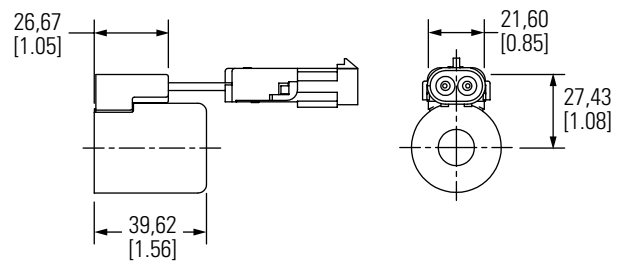

**F0**  
**Weather-Pack, Male**

Where measurements are critical request certified drawings. We reserve the right to change specifications without notice.

C

Dimensions

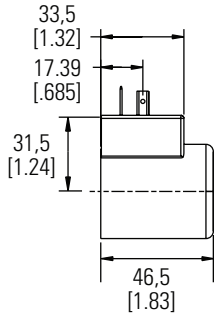

**G0**  
DIN 43650-A Connector

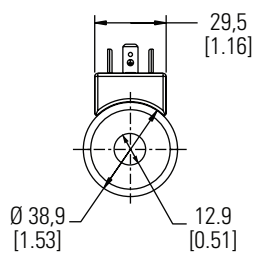

**J Series**

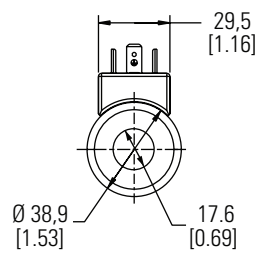

**H Series**

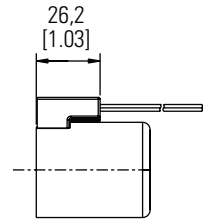

**W0**  
Leadwire

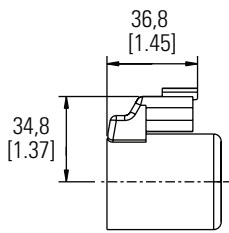
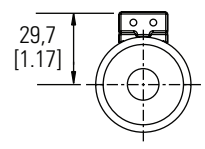

**N0**  
Deutsch male DTO4-2P integrated connector

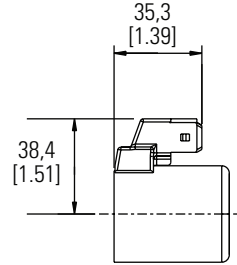
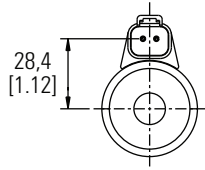

**Y0**  
AMP Junior timer integrated connector

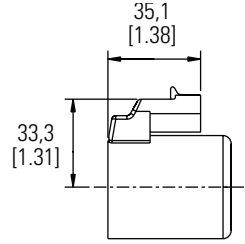
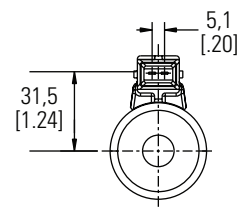

**D0**  
Metri-Pack 150 Male, integrated connector

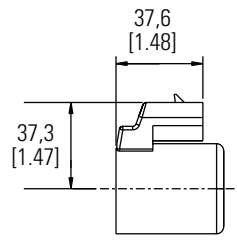
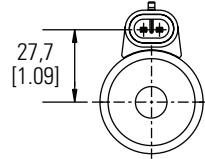

**J0**  
Metri-Pack 280 Male, integrated connector

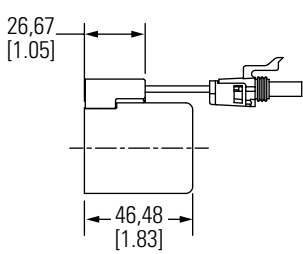
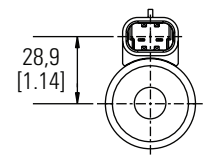

**E0**  
Weather-Pack, Female

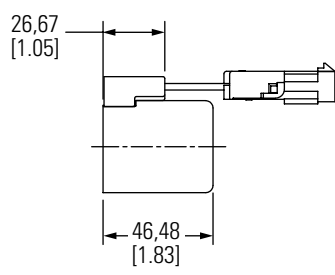
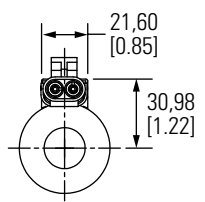

**F0**  
Weather-Pack, Male

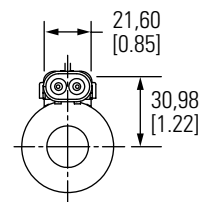

Where measurements are critical request certified drawings. We reserve the right to change specifications without notice.