

4CK30 - Check valve

Pilot-to-open, poppet type
30 L/min (8 USgpm) • 350 Bar (5000 psi)

www: www.salushydraulics.pl
e-mail: pl@salushydraulics.pl
shop/sklep: www.salushydraulics.pl/sklep/

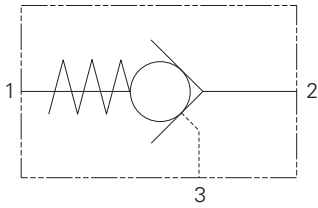

Operation

Pressure on the valve port 2 causes the poppet to lift against the spring force, allowing the flow to the cylinder port 1. Reverse flow is prevented by the poppet reseating. Pressure applied to the pilot port 3 will overcome the cylinder port pressure and lift the poppet from its seat, allowing flow from the cylinder to valve port.

Features

Hardened and ground poppet gives excellent flow capability for valve size, positive sealing and long working life. Cartridge construction allows installation in actuators, manifold blocks and Hydraulic Integrated Circuits. Fits the same cavity as the overcenter valves of a similar size.

Sectional view

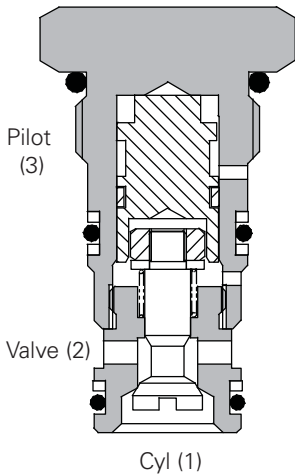

Performance data

Ratings and specifications

Figures based on: Oil Temp = 40°C Viscosity = 32 cSt (150 SUS)

Rated flow	30 L/min (8 USgpm)
Max setting	350 bar (5000 psi)
Pilot ratio	3:1
Cartridge material	Working parts hardened & ground steel. Electroless zinc plated body.
Standard housing material	Standard aluminium (up to 210 bar) Add suffix "377" for steel option
Mounting position	Unrestricted
Cavity number	A6610 (See section M)
Torque cartridge into cavity	45 Nm (33 lbs ft)
Weight	4CK30 0.08 kg (0.18 lbs) 4CK35 0.34 kg (0.75 lbs) 4CKK35 0.76 kg (1.67 lbs)
Seal kit number	SK430 (Nitrile) SK430V (Viton®)
Recommended filtration level	BS5540/4 Class 18/13 (25 micron nominal)
Operating temperature	-30°C to +90°C (-22° to +194°F)
Leakage	0.3 milliliters/min nominal (5 dpm)
Nominal viscosity range	5 to 500 cSt

Viton is a registered trademark of E.I. DuPont

Description

Pilot check valves allow flow to pass in one direction, with a low pressure drop, then prevent reverse flow until pilot pressure is applied. There are many applications for this valve type, the most common being to lock and hold a cylinder, or another hydraulic actuator, in position.

These valves are ideally suited for fitting directly into a cylinder, giving economy of installation, direct control of cylinder movement and ease of servicing.

Pressure drop

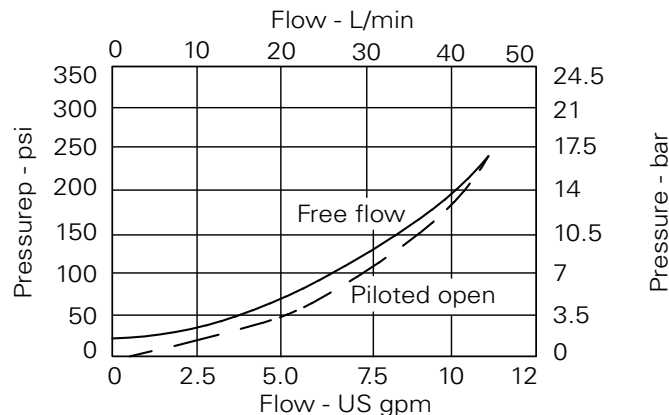

Where measurements are critical request certified drawings. We reserve the right to change specifications without notice.

4CK30 - Check valve

Pilot-to-open, poppet type
30 L/min (8 USgpm) • 350 Bar (5000 psi)

Model code

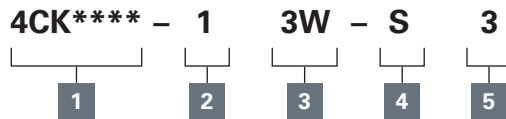

1 Basic code

4CK30 - Cartridge Only
4CK35 - Cartridge and Body
4CKK34 - Cartridges and Dual Body

2 Pilot port size

1 - Internal

3 Port sizes

Code	Port size	Housing number - body only			
		Aluminium single	Steel single	Aluminium double	Steel double
3W	3/8" BSP. 1/4" BSP Pilot Port	B6743	B12823	B6836	B13803
6T	3/8" SAE. 1/4" SAE Pilot Port	B10536		B10805	
8T	1/2" SAE. 1/4" SAE Pilot Port	B7884	84811	B30237	B11812

4 Seals

S -Nitrile (For use with most industrial hydraulic oils)
SV -Viton (For high temperature and most special fluid applications)

5 Optional pilot seal

Omit if not required

Dimensions

mm (inch)

Cartridge only

Basic code

4CK30

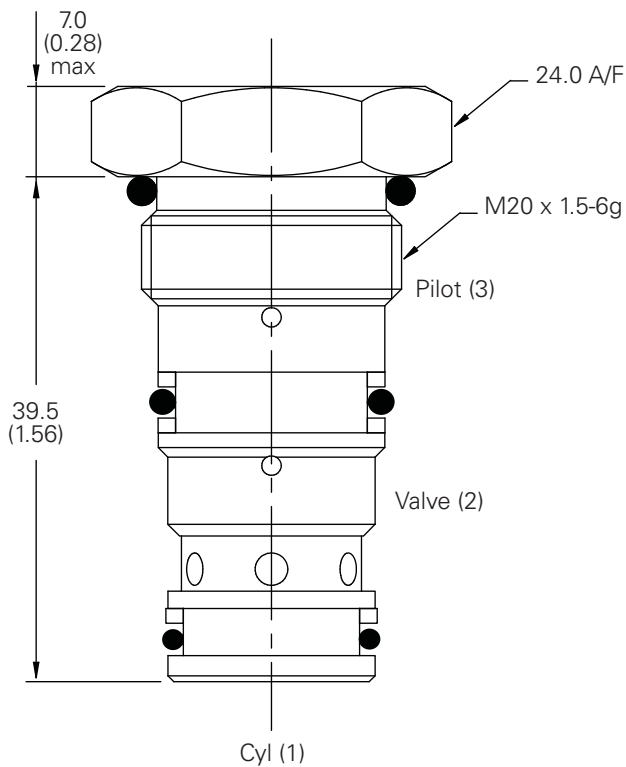

Single valve

3/8", 1/2" Ports

Basic code 4CK35

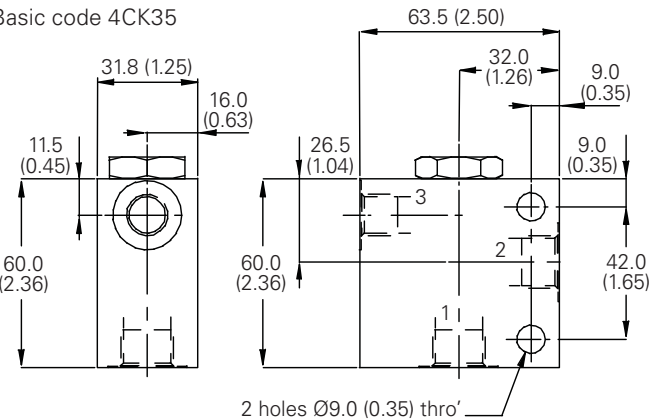

Dual valve

3/8", 1/2" Ports

Basic code 4CKK34

Internally cross piloted

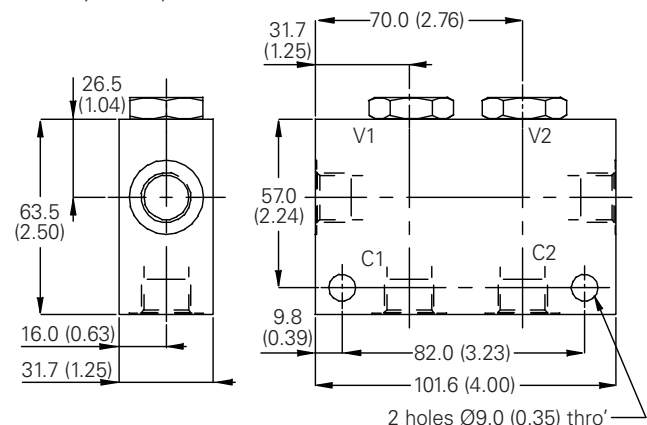

Note: For applications above 210 bar (3000 psi) please consult our technical department or use the steel body option.

Where measurements are critical request certified drawings. We reserve the right to change specifications without notice.